

## INSTALLATION INSTRUCTIONS FOR BLOWER KITS FBK-100 (CATALOG NO. 80L84) AND FBK-200 (CATALOG NO. 80L85) FOR USE WITH FIREPLACES

### GENERAL INFORMATION

These blower kits may be used with various models of fireplaces. The FBK-100 blower kit is used when wall-mounted ON/OFF blower switch is desired, and the FBK-200 when wall-mounted variable speed blower control is desired. The blower is installed beneath the firebox. Room air is drawn in through the bottom area of the fireplace, heated as it passes across the firebox, and discharged through the upper panel/louver area at the top of the fireplace. Kit FBK-100 contains one blower, two Velcro strips and these instructions. Kit FBK-200 contains one blower, one speed control switch, two Velcro strips and these instructions.

**Note:** Velcro strips are for use in **Step 6 D on page 2** only.

See Installation Instructions on the following pages:

Wood Fireplaces - See Pages 1-3.

D-Vent and B-Vent Fireplaces - See Pages 1-3.

Universal Vent Free Fireplaces - See Page 4.

### INSTALLATION INSTRUCTIONS

**Note:** In Universal Vent-Free fireplace applications refer to the installation instructions packaged with the fireplace for additional information.

**Step 1.** Turn off the fireplace and allow it to cool before proceeding.

**Step 2.** If the appliance is connected to 120 volt power, disconnect the power.

**Step 3.** If unit is a gas fireplace, shut off the gas supply to the fireplace.

**Step 4. Gas fireplaces -**

Open the lower panel (clean face models) or louver assembly (louvered models) by pushing in simultaneously the left and right side of the panel or louver assembly.

On Merit Fireplaces, remove the bottom panel or louvers by removing the screw at each end of the panel or louvers, retain the end spacers, and then pull the panel or the louvers from the unit.

On Elite-2 Fireplaces, remove the bottom door (panel or louvers) by sliding the hinge pin, located at the door's left side, to the right until it disengages from the left corner post hole. Pull the door diagonally to the left, away from the fireplace.

**Wood-burning fireplaces -**

*When equipped with a louver panel* - Push the two fireplace opening screens toward the middle of the unit to expose the louver panel retaining screw at each end of the panel. Remove the retaining screws and then pull the panel from the unit.

*When equipped with a grille* - Remove the bottom grille by lifting it up near its outer support rods. It must be lifted high enough to clear the support rod retaining holes located in the cabinet bottom flange. Then pull the bottom of the grille away from the fireplace and set the grille aside.

**Step 5. Elite-2 Series Gas Fireplaces** - Remove the modesty panel as follows: lift the modesty panel by the tab on the panel's right end, pull the right end of the panel away from cabinet and then pull the panel diagonally out of the corner post slots on the left side of the unit. Remove the modesty panel carefully, so that none of the wires become loose or disconnected.

**Step 6. A - Gas Fireplaces - Front-open direct vent and B-vent units** - Slide the blower assembly through the front opening to the middle rear area of the cabinet base. Position the blower assembly so that the tabs (located on the cabinet base) are seated in the notches of the blower bracket. Then bend the tabs over to secure the blower assembly (**Figure 1**).

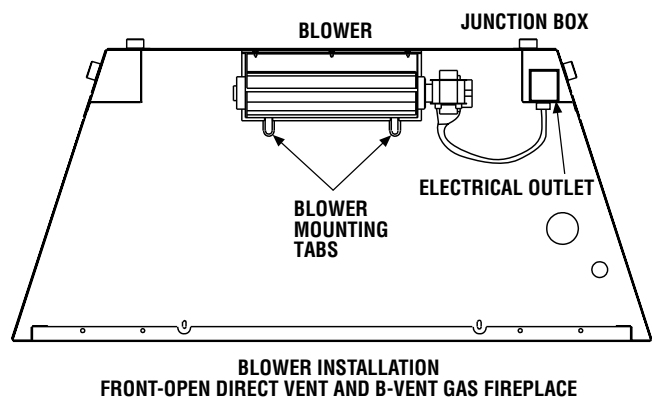

**Figure 1**

**Step 6. B - Gas Fireplaces - Multi-open direct vent units -**

Open all remaining bottom hinged-panels. Slide the blower assembly through the closest opening to the flue side of the cabinet base. Position the blower assembly so that the tabs (located on the cabinet base) are seated in the notches of the blower bracket. Bend the tabs over to secure the blower assembly. **See Figure 2 or 3.**

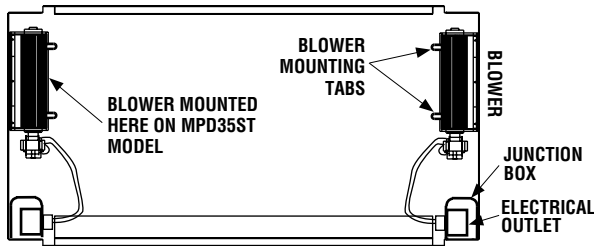

**BLOWER INSTALLATION  
MULTI-OPEN DIRECT VENT GAS FIREPLACE  
(See-through, Peninsula, Corner Left)**

**Figure 2**

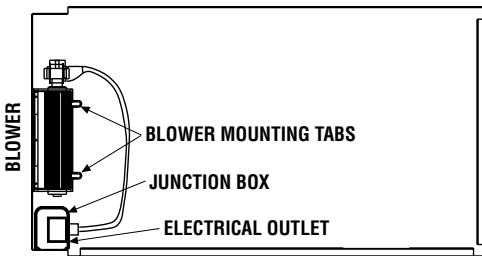

**BLOWER INSTALLATION  
MULTI-OPEN DIRECT VENT GAS FIREPLACE  
(Corner Right)**

**Figure 3**

**Step 6. C - Gas Fireplaces - Multi-open vent-free units -**

Open all remaining bottom hinged-panels. Remove the blower shield located across the inside right section of the unit. **See Figure 4.** Also refer to the installation instructions packaged with the fireplace for additional information on shield removal. Slide the blower assembly through the closest opening to the flue side of the cabinet base. Position the blower assembly so that the tabs (located on the cabinet base) are seated in the notches of the blower bracket. Bend the tabs over to secure the blower assembly. Reinstall the blower shield with the blower cord routed to the electrical outlet.

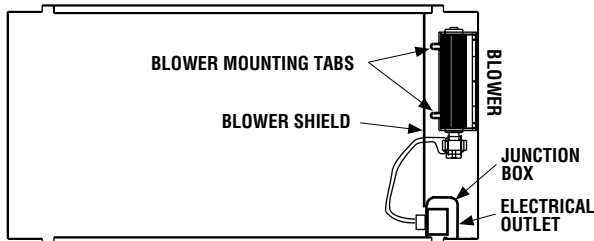

**BLOWER INSTALLATION  
MULTI-OPEN CATALYST AND VENT-FREE GAS FIREPLACE  
(See-through, Peninsula)**

**Figure 4**

**Step 6. D - Wood-burning fireplaces (other than vent-free) -**

Place the two mating halves of each of the two Velcro sections together. Peel the backing from one side of both of the mating pairs and stick the pairs to the back of the blower housing as shown in **Figure 5.**

Wipe the inside surface of the bottom of the unit of any excess oil or debris. Peel the backing from the other side of the two mated Velcro strips. Slide the blower assembly through the front opening of the unit (avoiding any contact between the sticky blower bottom and the cabinet). Position the blower assembly as shown in **Figure 6,** pressing firmly down on the blower in order to provide a positive blower to base attachment.

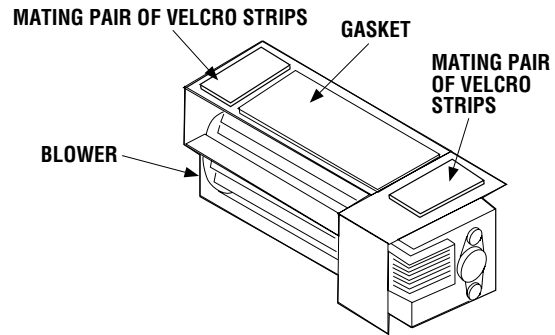

**INSTALLING VELCRO STRIPS TO BLOWER BASE**

**Figure 5**

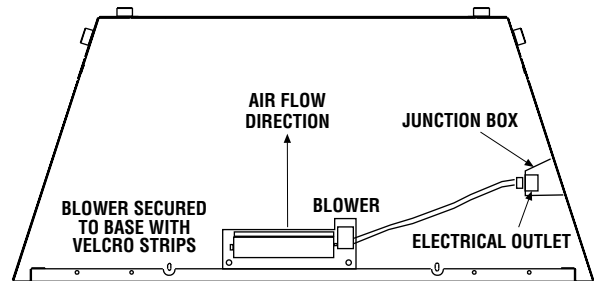

**BLOWER CENTERED SIDE TO SIDE AT THE FRONT OF THE UNIT  
BLOWER INSTALLATION WOOD-BURNING FIREPLACES  
(OTHER THAN VENT-FREE)**

**Figure 6**

**Step 7.** Install the field-provided ON/OFF switch (FBK-100 Kits) or the kit-provided variable speed control (FBK-200 Kits) in a convenient location on a wall, near the fireplace.

**Step 8.** Route a 3-wire, 120Vac power line to the ON/OFF switch (FBK-100 kits) or variable speed control (FBK-200 kits) as shown in **Figure 7.** Then route the wires to the unit's junction box. Remove the receptacle by removing the two securing screws. Connect the supply wires to the receptacle as shown in **Figure 7,** ensuring that the polarity (as determined by the colors of the wires) is exactly as shown. Reinstall the receptacle.

**Step 9.** Plug the blower cord into the top receptacle.

**Step 10. Elite-2 Series Gas Fireplaces -** Reinstall the modesty panel. Reinstall the modesty panel carefully, so that none of the wires become loose or disconnected.

**Step 11. Gas fireplaces -**  
Reinstall the bottom panel or louver assembly.

**Wood-burning fireplaces -**  
Reinstall the bottom louver panel or grille.

**Step 12.** Restore the electrical power to the unit.

**Step 13.** Start the fireplace by following the procedure indicated in the lighting instructions section of the Homeowner's Care and Operating Instructions manual supplied with the fireplace.

**Step 14.** Check the start up and shutdown, and the running operation of the blower. If the variable speed control is being used, check its operation.

**IMPORTANT: Ground lead must be connected to the green screw located on the junction box. Failure to do so will prevent the appliance from operating.** The appliance must be electrically grounded in accordance with local codes or, in the absence of local codes, the National Electrical Code, ANSI/NFPA 70-(latest edition). (In Canada, the current CSA C22-1 Canadian Electrical Code.)

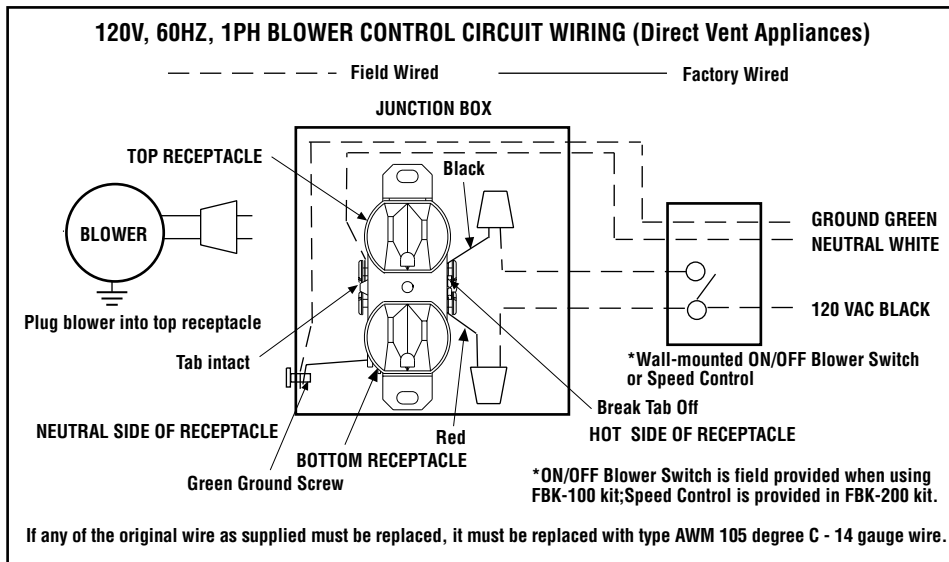

Figure 7

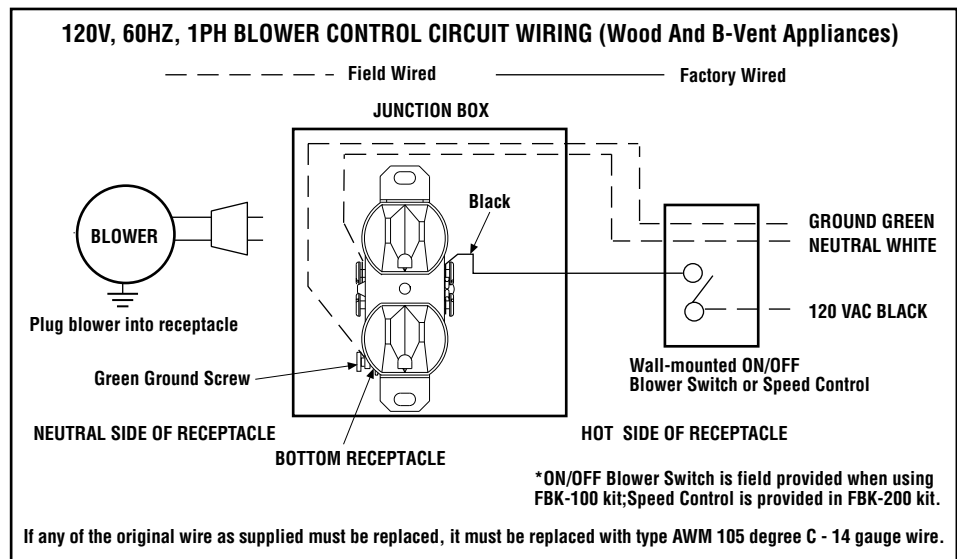

Figure 8

**Universal Vent Free Fireboxes  
Installation Instructions -  
FBK-100 or FBK 200 Blower Kits  
JBK Junction Box Kit**

**Step 1.** Follow the instructions below for the model you are installing:

**Models UVFRC-4228, UVFRC-4228-H, UVFRC-3628 and UVFRC-3628-H:**  
Lift out the bottom refractory panel (see **Figure 9**).

**Models UVF-36 -** Using a screwdriver remove the screw from the blower access panel as shown in **Figure 10**. Slide the panel to the right until the flange clears the opening. Remove the panel and set aside.

**Step 2.** Remove the rectangular knock-out (for J-Box) on the right side of the unit. Install the junction box and electrical outlet below the firebox floor into the rectangular opening on the right side cabinet panel where you removed the knock-out (see **Figures 11 & 12**). The junction box/ electrical kit is sold separately.

**Note:** Pass the wires through the hole, then squeeze the J-Box flanges together to fit into opening.

**Step 3.** Loosely tie a knot in the power cord to take up slack (see **Figure 13**).

**Step 4.** Locate the tabs shown in **Figure 14**. Position the blower assembly so that the tabs (located on the cabinet base) are seated in the notches of the blower bracket. Bend the tabs over to secure the blower assembly (see **Figure 15**).

**Step 5.** Plug blower power cord into the J-Box electrical outlet.

**Step 6.** Connect electrical outlet and switch wires to the power supply; 3-wire, 120 VAC, 60 Hz, 1 ph power supply (see **Figure 8**).

**FBK-100 Kits -** Install a field-provided (or P/N 85L87) ON/OFF wall switch in a convenient location on a wall, near the fireplace.

**FBK-200 Kits -** Install the kit-provided variable speed control (rheostat) in a convenient location on a wall, near the fireplace.

**Step 7.** Follow the instructions that follow for the model you are installing:

**Models UVFRC-4228, UVFRC-4228-H UVFRC-3628 and UVFRC-3628-H :**  
Reinstall the bottom refractory panel that was removed on **Step 1** (see **Figure 9**).

**Models UVF-36:**  
Reinstall the blower access panel that was removed on **Step 1** (see **Figure 10**).

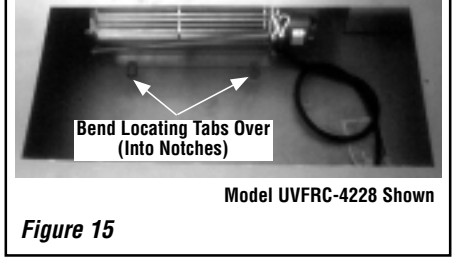
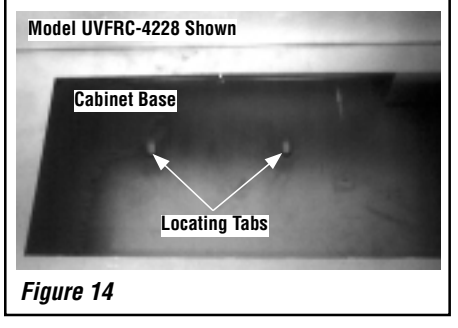
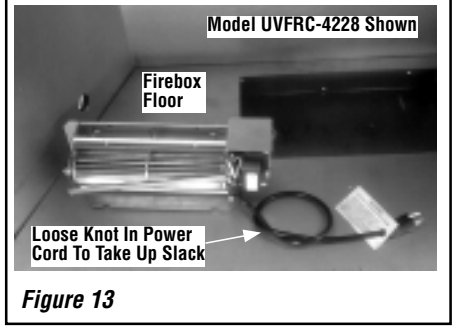
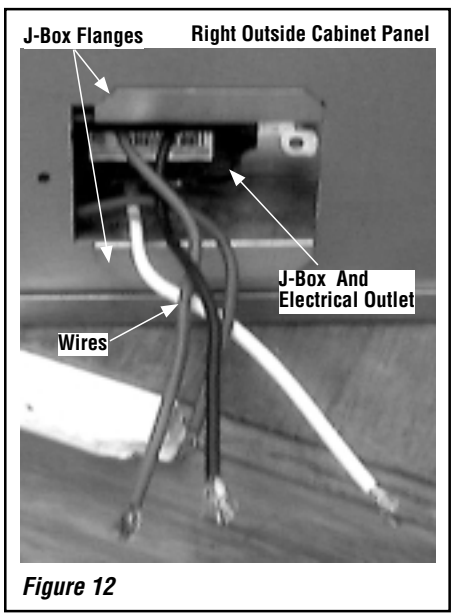
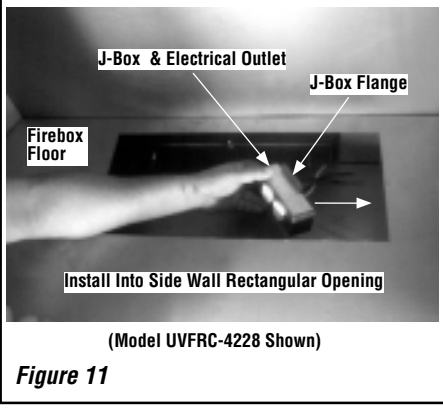
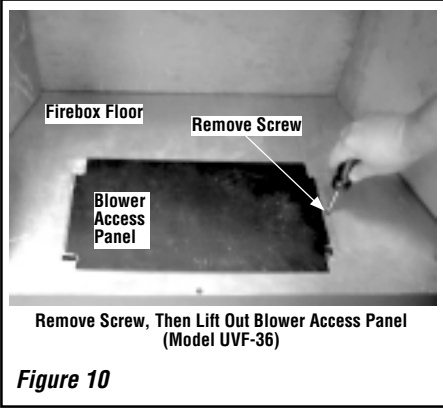
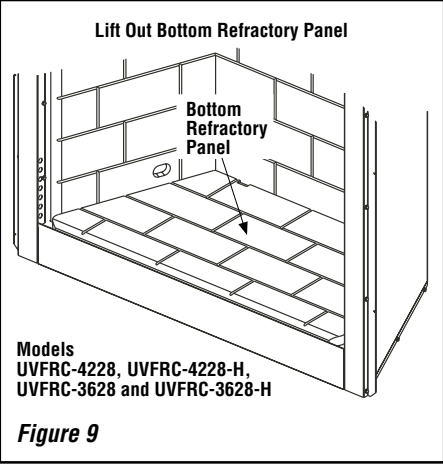

NOTE: DIAGRAMS & ILLUSTRATIONS NOT TO SCALE.

The manufacturer reserves the right to make changes at any time, without notice, in design, materials, specifications, prices and also to discontinue colors, styles and products. Consult your local distributor for fireplace code information.

