



HEARTH PRODUCTS

HEARTH PRODUCTS
KITS AND ACCESSORIES

775,274M
Rev. A, 02/2009

WINSLOW™ DOOR TRIM KITS
MODELS PS40 AND PI40

INSTALLATION INSTRUCTIONS FOR INSTALLING DOOR TRIM KITS FOR USE WITH WINSLOW™ MODELS PS40 AND PI40 PELLET APPLIANCES



KIT CONTENTS (See Figure 1):

- 2 ea. Trim Pieces
- 6 ea. #10 nuts
- 6 ea. #10 washers
- 1 ea. Instruction Sheet

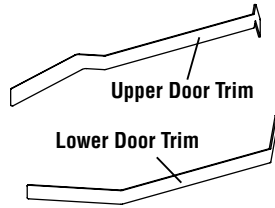

TOOLS NEEDED:

3/8" Nut Driver or Socket Wrench

Winslow Door Trim Kits		
Cat. No.	Model	Description
79038	P40DT-B	Black Door Trim Kit
79034	P40DT-G	Gold Door Trim Kit
79037	P40DT-N	Nickel Door Trim Kit
79035	P40DT-BRN	Brushed Nickel Door Trim Kit
79036	P40DT-BLN	Black Nickel Door Trim Kit

GENERAL INFORMATION

If you encounter any problems, need clarification of these instructions or are not qualified to properly install this kit, contact your local distributor or dealer.

Read this instruction sheet in its entirety before beginning the installation.

ALL WARNINGS AND PRECAUTIONS IN THE INSTALLATION AND OPERATION MANUAL PROVIDED WITH THE APPLIANCE APPLY TO THESE INSTRUCTIONS.

TURN OFF THE APPLIANCE AND ALLOW IT TO COMPLETELY COOL BEFORE PROCEEDING.

INSTALLATION INSTRUCTIONS

Step 1. Remove the trim pieces and hardware from its packaging and ensure that all pieces are present before beginning installation. Take care not to scratch finished surfaces (see *Figure 1*).

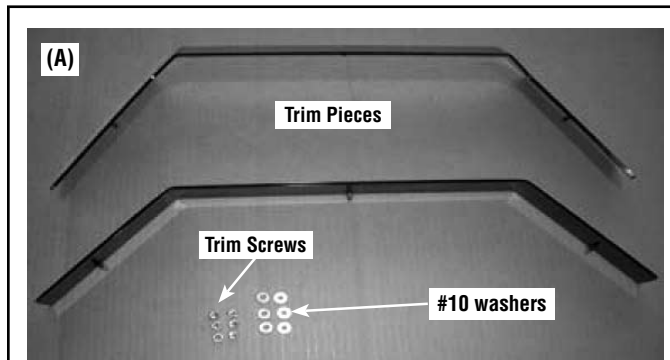

Figure 1 - Kit Contents

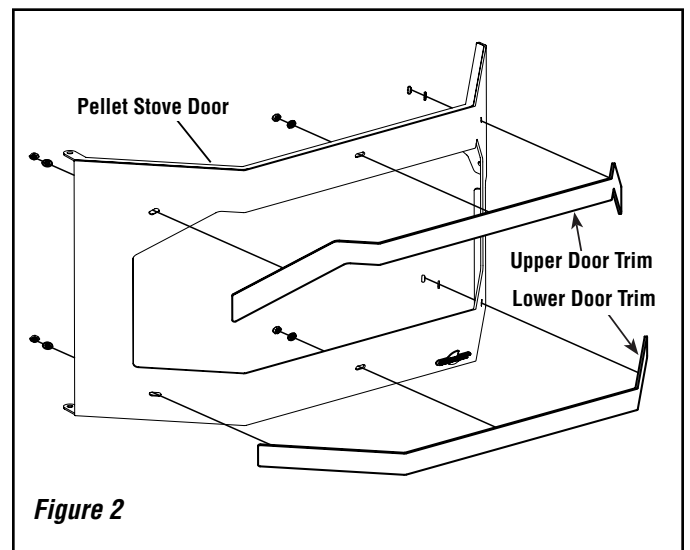

Figure 2



IMPORTANT

If you have a gold or nickel trim, be sure to clean them with a soft cloth and household glass cleaner prior to burning the insert. Fingerprints left on the plated surfaces while burning will usually remain on the finish permanently.

- Step 2.** Open right and left side door. The side doors swivel open towards the back of the stove. See *Figure 3*.
- Step 3.** Open front door. Put door trim in place by inserting trim studs into the corresponding holes in the front door (*Figures 3 and 4*). The upper door trim will only fit in one direction, but the lower door trim can be installed incorrectly. When placing the lower door trim, make sure that the distance between the top edge of the lower door trim to the glass in the door is 9/16" (see *Figure 5*).
- Step 4.** Place one washer on each stud. Using a 3/8" nut driver, snug up the nuts on each piece of trim. Do not finish tightening the nuts yet. See *Figure 6*.
- Step 5.** There should be approximately a 7/8" (22 mm) gap between the top edge of the upper door trim and the top edge of the front door and a 1-1/2" (38 mm) gap between the lower door trim to the bottom of the front door. Visually inspect the alignment of the trim and adjust if necessary. See *Figure 7*.
- Step 6.** Finish tightening nuts. **CAUTION - DO NOT OVER-TIGHTEN NUTS, DIMPLING OF THE TRIM WILL OCCUR!!!**

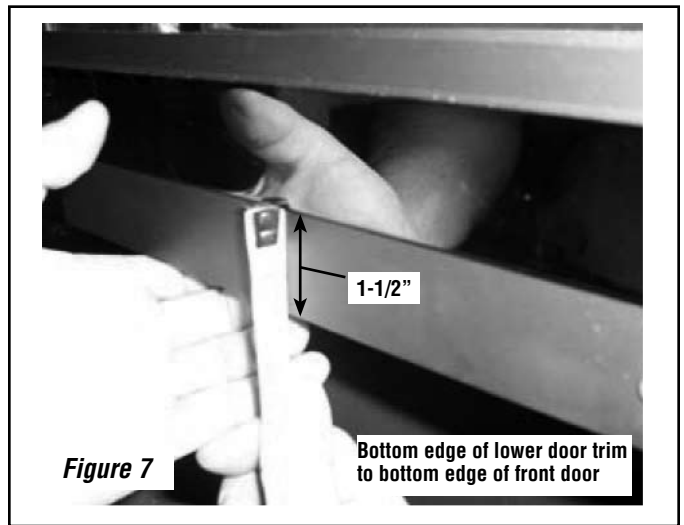
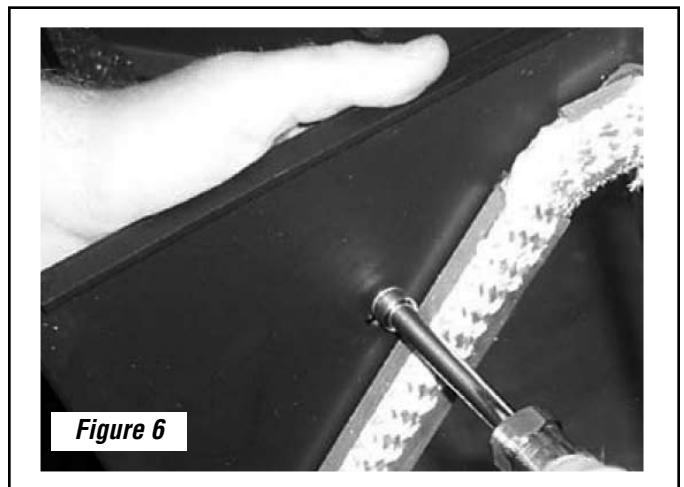
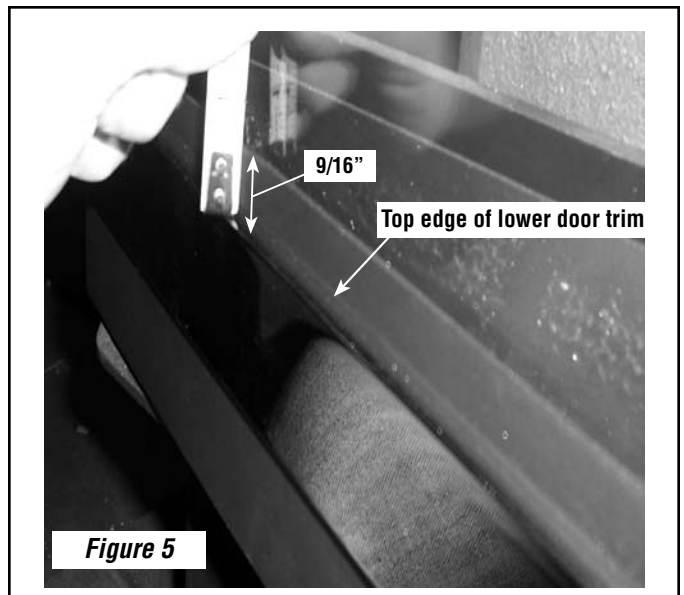
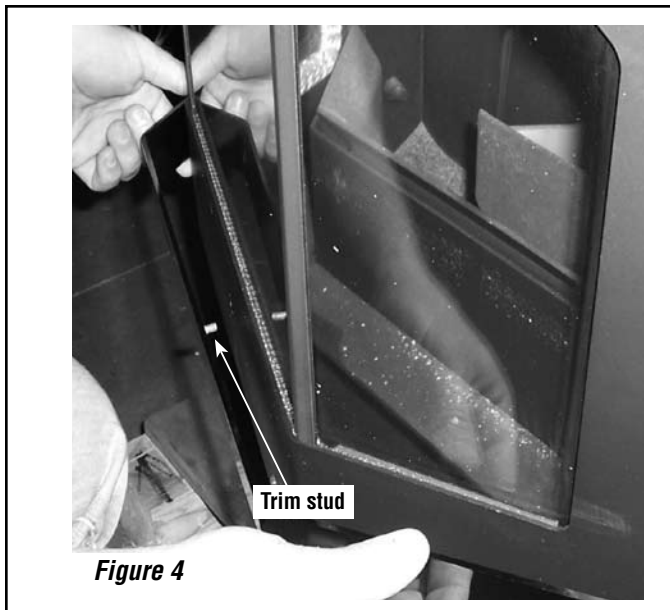
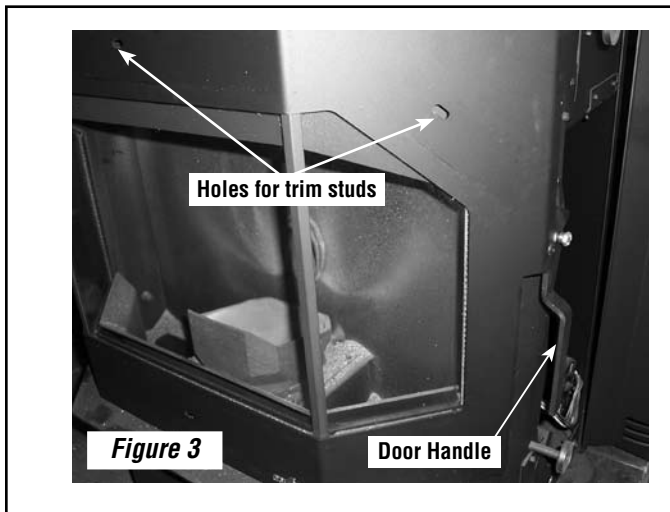

NOTE: DIAGRAMS & ILLUSTRATIONS ARE NOT TO SCALE.

Lennox Hearth Products reserves the right to make changes at any time, without notice, in design, materials, specifications, prices and also to discontinue colors, styles and products. Consult your local distributor for fireplace code information.